

Product Specifications

SD59A220IN-HC

2Mp 1080P 20x Ultra-high Speed IR HDCVI PTZ Dome

Camera



Features

- 20x optical zoom
- Max. 25/30fps@1080P(1920×1080) & 20/30/50/60fps@720P resolution
- DWDR, Day/Night(ICR), Ultra DNR, Auto iris, Auto focus
- Max 400°/s pan speed, 360° endless pan rotation
- Control over coaxial cable, long distance real-time transmission
- HD and SD switchable
- Up to 300 presets, 5 auto scan, 8 tour, 5 pattern
- Built-in 2/1 alarm in/out
- Support intelligent 3D positioning with DH-SD protocol
- IR Distance up to 100m
- IP66,OSD

Product Specifications

SD59A220IN-HC

Technical Specifications

Model	SD59A220IN-HC
Camera	
Image Sensor	1/2.8" Exmor CMOS
Effective Pixels	1920(H) x 1080(V), 2Megapixels
Horizontal Resolution	≥1000TVL
Scanning System	Progressive
Electronic Shutter Speed	1/1 ~ 1/30,000s
Min. Illumination	Color: 0.05Lux@F1.6; B/W: 0.005Lux@F1.6; 0Lux (IR on)
S/N Ratio	More than 50dB
Resolution	25/30fps@1080P, 25/30/50/60fps@720P
Video Output	1-channel BNC HDCVI high definition video output/ CVBS standard definition video output (Can switch)
Camera Features	
Day/Night	Auto(ICR) / Color / B/W
Backlight Compensation	BLC / HLC / DWDR (Digital WDR)
White Balance	Auto, ATW, Indoor, Outdoor, Manual
Gain Control	Auto / Manual
Noise Reduction	2D/3D
Privacy Masking	Up to 24 areas
Digital Zoom	16x
Lens	
Focal Length	4.7mm~94mm (20x Optical zoom)
Max Aperture	F1.6 ~ F5.0
Focus Control	Auto / Manual
Angle of View	H: 54.1° ~ 3.2°
Close Focus Distance	100mm ~ 1000mm
PTZ	
Pan/Tilt Range	Pan: 0° ~ 360° endless; Tilt: -15° ~ 90°, auto flip 180°
Manual Control Speed	Pan: 0.1° ~300° /s; Tilt: 0.1° ~200° /s
Preset Speed	Pan: 400° /s; Tilt: 300° /s
Preset	300(DH-SD),255(Pelco-P/D)
PTZ Mode	5 Pattern, 8 Tour, Auto Pan, Auto Scan
Speed Setup	Human-oriented focal length/ speed adaptation
Power up Action	Auto restore to previous PTZ and lens status after power failure
Idle Motion	Activate Preset/ Scan/ Tour/ Pattern if there is no command in the specified period
Protocol	DH-SD, Pelco-P/D (Auto recognition)
IR Distance	100m
Audio	

Product Specifications

SD59A220IN-HC

Interface	1 channel In
Auxiliary Interface	
RS485	1
Alarm	2/1 channel In/Out
General	
Power Supply	AC24V/3A ($\pm 10\%$)
Power Consumption	12W, 25W (IR on)
Working Environment	-40°C ~ 70°C / Less than 90% RH
Ingress Protection	IP66
Dimensions	$\Phi 186.0(\text{mm}) \times 310(\text{mm})$
Weight	3.5Kg

Dimensions (mm)

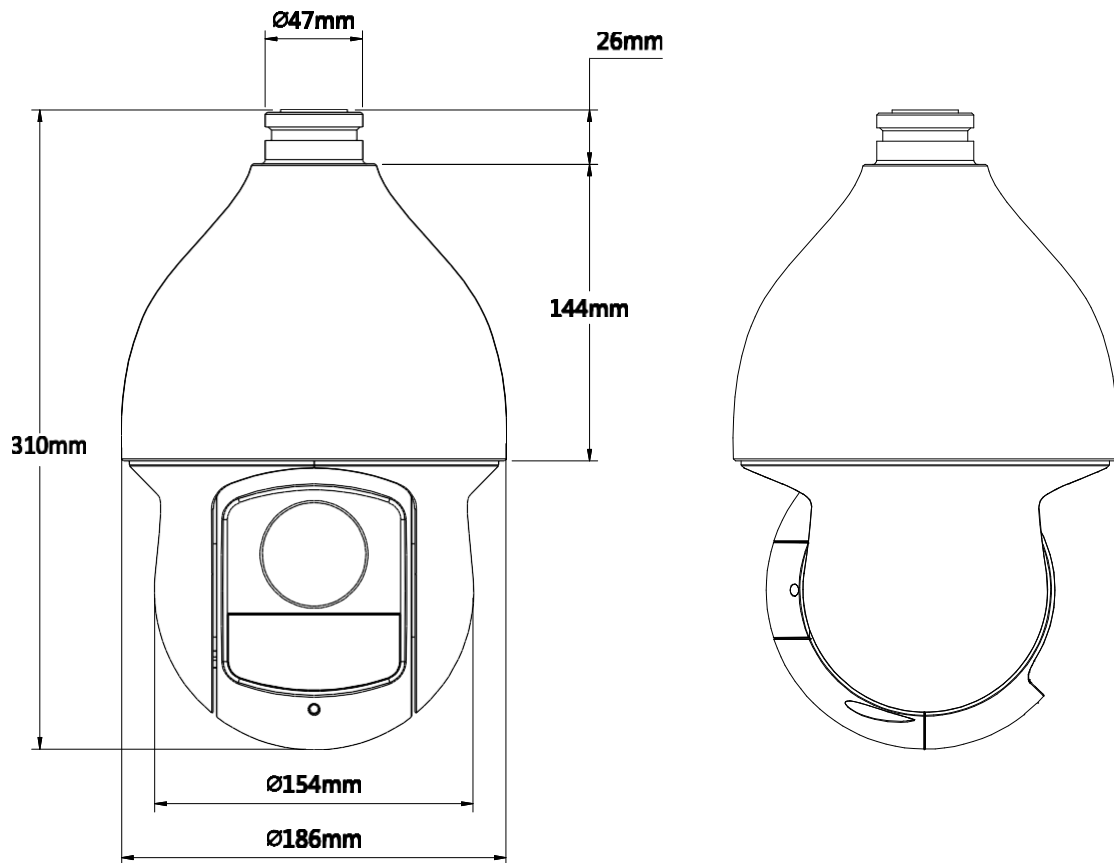

Product Specifications

SD59A220IN-HC

Accessories

		
DH-PFB300S	DH-PFA110	Power Supply

Accessories (Optional)

		
DH-PFB300C	DH-PFA112	DH-PFA113

		
DH- PFA120	DH-PFA150	DH-PFA151